

Angle of Attack Indicator

An inexpensive alternative

DAVE BARKER, EAA 587700

This device is really just a simple weather vane with the axis mounted horizontally to indicate relative wind in the vertical direction as opposed to an azimuth for a weather vane on the barn.

Why an angle of attack (AOA) indicator? Because it can tell you what the aircraft is really doing compared to the typical variable incidence of the pitot tube that is rigidly mounted under the wing. The pivoting vane of the AOA indicator always flies directly into the relative wind. The angle it makes with the attack angle of the wing can be measured and provides accurate flight status in maneuvers such as short take-off and landing attitudes. It uses a magnetic field sensor called a linear Hall-effect sensor. This is a device that outputs a voltage proportional to the strength of a magnetic field. The vane carries a small permanent magnet that rotates it relative to the Hall sensor device located on the Delrin mount sleeve. The output voltage is used to drive a panel-mounted 10-segment multicolor bar graph display. The display LEDs change position and color from green to yellow to red as the angle of attack increases.

AOA display boards require minimal panel space but should be mounted high on the panel to stay within your peripheral field of vision while looking outside.

The hardest part of this project is deciding where to mount the vane assembly and routing the connecting cable through the wing to the sensor. The sensor vane needs to be located in the undisturbed airflow, away from

prop blast and wing empennage effects.

In many aircraft, mounting parallel to the side of the pitot tube structure is a good choice. My plane has a standard heated pitot tube structure, and I built a Delrin ring carrier for the Hall sensor and pivot bearing that slides on the pitot tube and positions the vane parallel and slightly behind the pitot intake port.

The vane and fin itself can be formed from plastic. I used a piece of Delrin rod equipped with an aluminum fin. It mounts on a 1/8-inch stainless steel pivot shaft. The vane carries a small 0.375-inch-long rectangular permanent

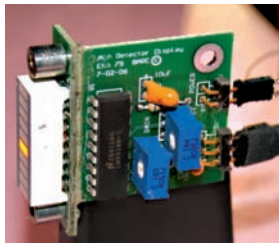

AOA display boards require minimal panel space but should be mounted high on the panel to stay within your peripheral field of vision while looking outside.

magnet mounted in the inboard face of the vane about 1/4-inch ahead of the pivot shaft. The north-to-south side face of the magnet rolls about the pivot parallel to the Hall sensor face. By keeping the arc travel within the physical length of the magnet, we can achieve a linear position voltage output from the Hall sensor versus angle of displacement of the moving vane.

To minimize aircraft panel real estate, the topside of the PC board is scored about .030-inch deep along the side of the bar graph display. Mount the bare board in a vice and back away from the score mark against a sharp (square) edge. A mill vice is perfect for this operation.

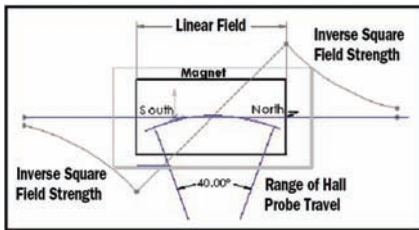

Hall output voltage versus position

By carefully pushing the display portion backwards over the sharp edge of machine vise, the PC board folds the display portion 90 degrees without breaking the connecting traces on the back surface. Hold it in the 90 degree position and fill the gap with glue. If this is done carefully, you will not break any of the copper traces on the backside of the board. However, if you do damage a copper trace, scrape off the green solder mask on the broken trace, tin and bridge solder it with fine copper wire. The sensor portion of the circuit board is cut all the way through and can be broken out completely after the display fold process.

Trim off the unused portion of the Hall sensor board remnant, and install the Hall device magnetic field sensor, plug, and capacitor. This PC board is mounted on the Delrin ring sleeve support, which in turn carries

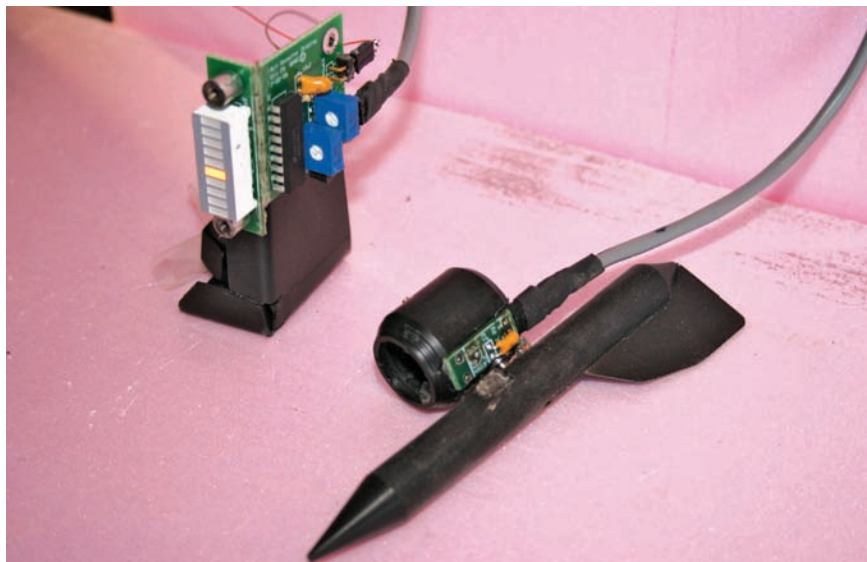

The panel display unit and sensor. Barker mated an aluminum fin to a Delrin rod to make the indicator. The Hall sensor is mounted on a Delrin ring that attaches the indicator to the pitot tube.

the moving vane equipped with its permanent magnet. The magnet moves across the face of the Hall sensor as the aircraft pitches up and down.

Assembly

Populate the board with the components as shown on the board annotation and the photos. Solder the parts in place and additionally solder the touching display and driver chip leads at the board fold. (This will provide additional structural strength.)

Install Hall sensor and plug on backside of the PC board. Mount in the pitot tube mount slot. The Hall sensor should be flush with the mount surface.

The most tedious portion of the job is usually the routing of the connecting cable (two-conductor plus shield) from the sensor through the wing to the aircraft instrument panel.

Calibration

The display board has two blue adjusting trimpots that allow scaling to fit the aircraft performance type. This will vary if you are flying a trike or a jet. The uppermost trimpot on the display board sets the gain (that is, how many bars the display

Acrylic Repair and Restoration Kit (EZ5000)

**SIMPLE, 2-STEP
GUARANTEED RESULTS**

www.Plastek LLC.com

**2009
AIRVENTURE
OSH KOSH
EAA**

July 27th-August 2nd, 2009
www.airventure.org

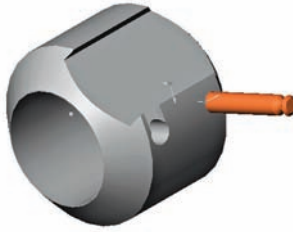

Mount and pivot bearing and vane shaft (small hole holds Hall sensor).



AOA Vane mounted next to Pitot tube.

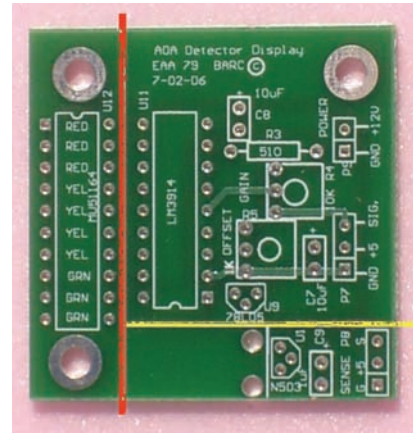

Board with plug and Hall sensor mounted on bottom side of PC board.

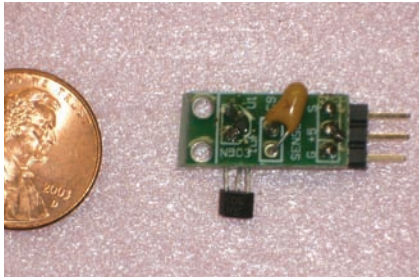

Board with plug and Hall sensor mounted on bottom side of PC board.

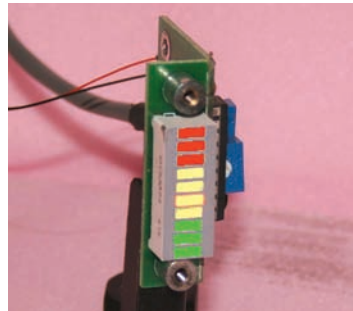

All LEDs on (not the normal display).

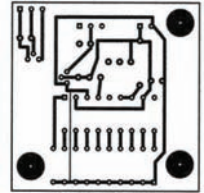
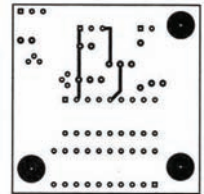
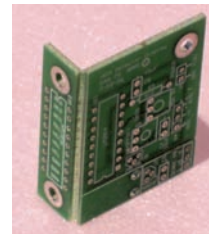

(right) Top, bottom and overlay PC board layout.

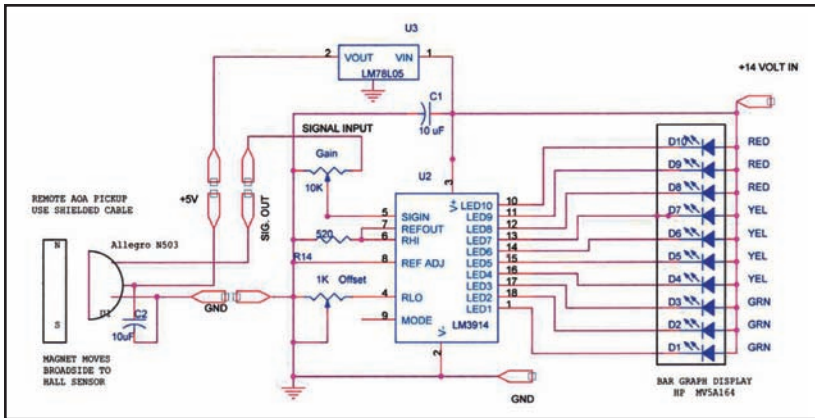

(left) AOA circuit board schematic.

moves up and down with each degree of vane rotation). The lower trimpot is an offset adjustment. This moves the span position (bottom green display element turn on). This bottom LED should be on when the aircraft is in straight and level flight. The upper red light should turn on at the stall angle for your particular aircraft and wing design; a range of between 15 to 40 degrees for most aircraft types.

Note: In ground calibration you will be pitching the vane downward to set the gain trimpot, which is the same as the wing pitching upward while the vane maintains a constant position to the relative wind. Please note the gain and offset pots are somewhat interactive and will require some

iteration to zero in on optimum.

Finally, please, if you are going to check out the limits of performance of your aircraft, do it with lots of altitude! This device is an indicator. It will not rescue you from sloppy piloting.

The AOA kit consists of:

- Electronic Components
- Double-Sided PC Display Boards, cut and scored
- N305 Hall Magnetic Sensor
- LM 78L05 Regulator
- LM 3914 Bar Graph Drive
- MV5A164 Multicolor LED Display
- 10K & 1K Pot
- 510-Ohm Resistor
- 1uF Capacitor
- 10uF Capacitor

- 3-Pin Plugs (2)
- 2-Pin Plug (1)
- Cable Termination Connectors (2)
- Power Terminal (1)
- 20 Feet of Two-Conductor plus Shield Cable

Mechanical Parts

- ¼-inch x 4-40 Swage-Type Mount (2)
- Prefab Delrin Sensor Vane and Fin
- Post Axle Components
- Neodymium Magnet
- Delrin Pitot Tube Mount Assembly

go direct
 To order visit www.BarkerAircraft.com