

White Paper Report
on
DC Power System Dynamics

Robert L. Nuckolls, III
AeroElectric Connection
Wichita, KS
www.aeroelectric.com

Revision –A- 14 March 2005
Revision –B- 20 March 2005
Revision –C- 22 March 2005

The test setup . . .

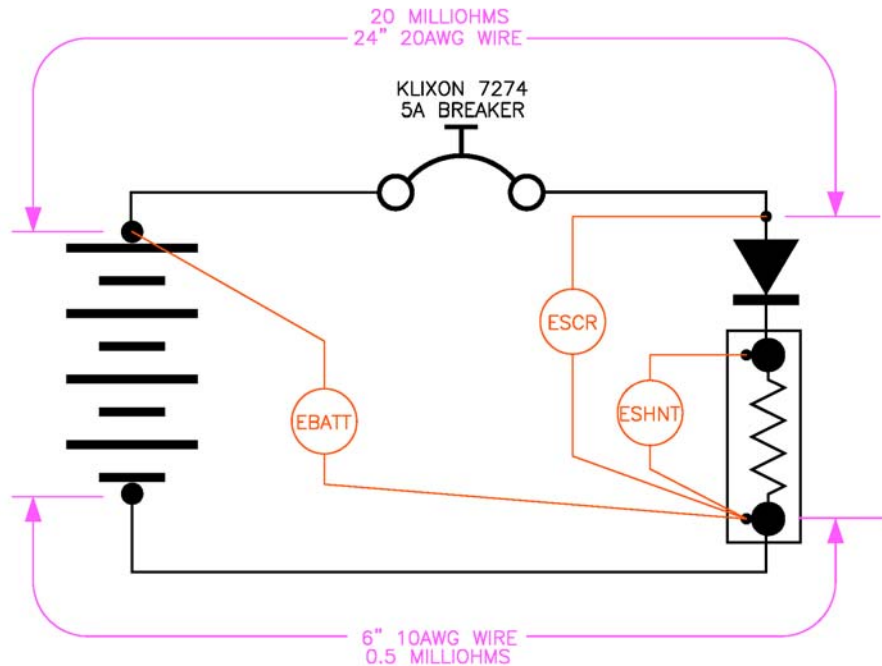

Materials:

A used 17 a.h. Panasonic battery supported by battery maintainer.

MCR69-1 Silicon Controlled Rectifier

500A/50mV shunt (100 micro-ohms)

Klixon 7274-2-5 circuit breaker.

20AWG wire

10AWG wire

Misc terminals and screws

to assemble per the adjacent drawing.

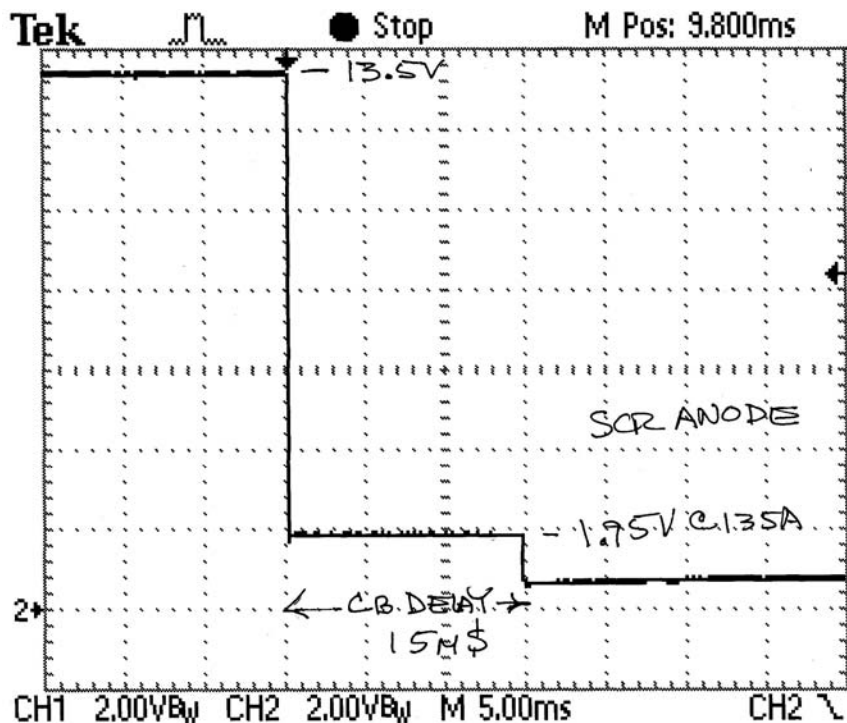

Test Equipment:

Tektronix TDS210 digital storage scope.

Test Procedure:

Set scope to watch SCR anode voltage on channel 2. Set channel 2 sensitivity to 2.0 volts/division. Connect channel 1 to read Eshunt at 10 mV/division.

Sweep at 5 mS/division. Trigger on falling edge of ch2 signal approx 8 volts. Set sweep mode for single sweep capture.

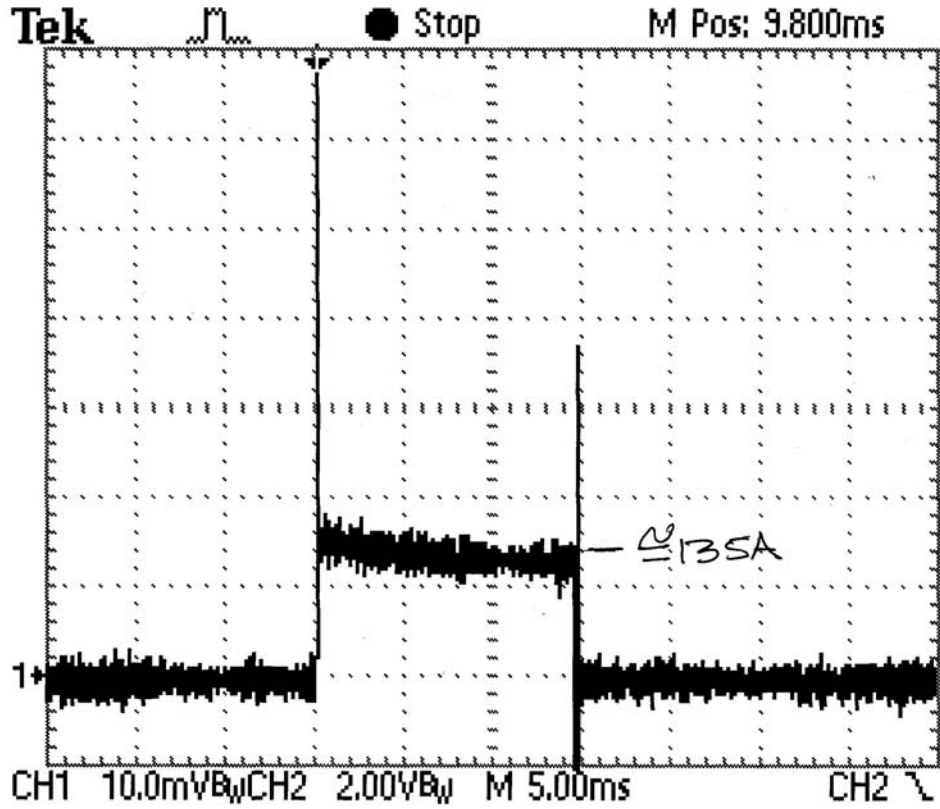

Trigger SCR. Plot channel 1 and channel 2 scope traces to hard copy.

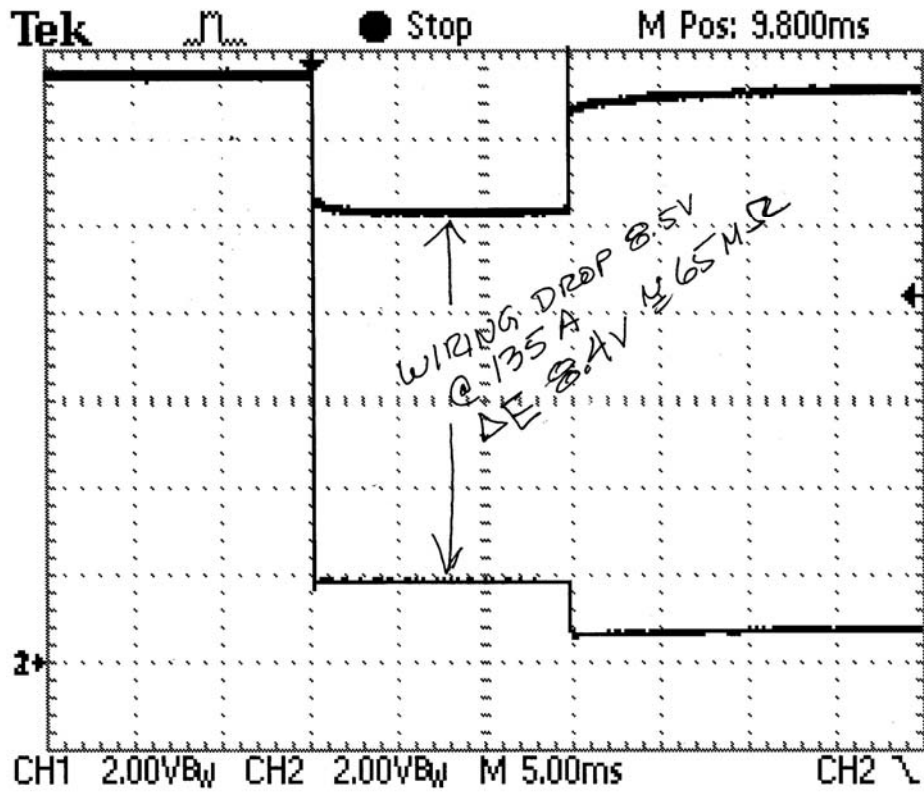

Move channel 1 to read battery voltage.

Reset crowbar breaker, reset scope for single sweep capture.

Trigger SCR and plot channel 1 and 2 traces to hardcopy.

Observations taken from recorded data:

- Current during crowbar interval is on the order of 135 amps
- Circuit breaker opens in 15 milliseconds after onset of crowbar current.
- Voltage drop across SCR during the crowbar event is just under 2.0 volts.
- Battery voltage sags to 10.4 volts during the crowbar event.

Calculations:

- Battery delta E for 135A load is about 2.4 volts for an internal impedance of about 17 m Ω . About what one would expect from a two year old battery that started out in the 8 to 10 milliohm range.
- Wiring drops during the crowbar event were about 8.4 volts for a loop resistance on the order of 62 m Ω .
- Energy dissipated in the SCR during the crowbar event was $E \cdot A/t$ or $2.0 \times 135 \times 0.015$ or 4 watt-seconds.

Analysis:

- This experiment illustrates the ways that resistance of individual features can stack on top of each other. 2-feet of 20AWG wire used to wire the experiment contributes only 20 m Ω of the 62 m Ω total we observed. The experiment has 6 crimped terminals and 6 bolted joints.
- Further, the circuit breaker when new is rated for a maximum voltage drop of 0.35 volts at 5A or ~~7 milliohms~~ 70 m Ω max. Better yet, let's go to the bench and check the breaker used. I measured 38 m Ω .
- So given the fixed values comprised of circuit breaker drop and wire for a total of 27.58 m Ω , ~~this leaves about 27 m Ω spread over the six terminals for an average resistance of 2.25 m Ω per joint.~~ This leaves only 4 m Ω of unaccounted for resistance which one might assign to terminal crimps and bolted joints . . . a value far more reasonable than the previously deduced value of 27 m Ω .

What if:

- Suppose we replace ol' soggy with a new battery in the 7 m Ω range for internal impedance. This is a battery that will source 500A before its terminal voltage drops below 9 volts.
- The new resistance for the crowbar event is now 62 + 7 or 69 m Ω which yields a new current value of $(12.5-2)/.069 = 152A$. Since the breaker is a thermal device it's response time is inversely proportional to the square of the current. It it opens in 15 mS at 135A, then it opens in 12 mS at 152A. Energy dissipated in the SCR is now $2 \times 152 \times .012$ or 3.7 watt-seconds. Slightly less than before.

- ~~Let's assume we could reduce the joint resistances by half with some more attention to cleaning/bonding. Our 27 m Ω of loop resistance drops to 13 m Ω of joint resistance + 20 m Ω of wiring + 7 m Ω of battery resistance for a total of 40 m Ω . The new crowbar event current rises to $(12.5 - 2) / .04 = 263\text{A}$. Opening time for the breaker goes to about 5 milliseconds. Energy dissipated in the SCR goes to $263 \times 2 \times .005 = 2.7$ watt-seconds.~~ This paragraph becomes totally irrelevant in light of mathematical errors corrected above.

- Let's consider both the what-if cases cited for bus voltage during the crowbar events. In the first case we put in a new battery with 7 m Ω resistance so the 152A pulse will drag the terminal voltage down to 11.4 volts.
- In the second case, the 263A pulse would drag terminal voltage down to 10.6 volts.
- Hmmm . . . let's put ol' soggy back in for an internal impedance of 17 m Ω (50 total). Now the crowbar current is 210 amps and terminal voltage falls to 8.93 volts. Whoops! This points out the value in keeping one's battery fresh. Low source impedance is not only critical to FAST operation of the crowbar ov system . . . it also drives overall stress on the crowbar module where we've seen that the higher the current, the faster it operates and the COOLER it is after the event is over.
- Now, let's put the alternator back into the system. Assuming it went into an ov condition such that the crowbar module trips, the alternator will contribute to the energy available to open the breaker. Consider the following:
 - In the bench test case where crowbar current was 135A . . . a 60A runaway alternator will contribute perhaps 70-75 amps of that current . . . but not all of it. The battery still has to supply the remainder to the tune of 50 amps. $50\text{A} \times .017\text{ m}\Omega$ of battery resistance produces a voltage drop of 1 volt. This means that if my bench test had included a 60A snarling alternator, the bus voltage during the crowbar event would have stayed above 11 volts.
 - In the case where we just clean up the wiring and have a crowbar pulse of 210 amps – 75 amps of “help” from alternator produces a battery current of 135 amps. $135\text{ amps} \times 17\text{ m}\Omega$ of battery impedance allows the bus to sag by 2.3 volts for a new bus voltage of about 10.2 volts.
 - Of course with clean wiring and a good battery, the $(263-75) \times .007 = 1.1$ volts drop or a bus voltage of 11.4 volts

What conclusions might we draw from the foregoing?

- Consider that while an increasing bus voltage triggers the crowbar event, from the time the SCR fires to the time when the breaker opens, the OV event is essentially under control because the crowbar module draws more than the alternator can produce. If the battery is participating in the crowbar event, then bus voltages during the event will fall in the ranges based on the battery's internal impedance and it's proportion of load sharing.
- Note that the voltage across the triggered SCR is on the order of 2 volts. If one uses a crowbar OV module in combination with an internally regulated alternator, field supply to the alternator is choked off at the 2 volt level as soon as the SCR fires . . . the alternator is already starved for field

current long before the breaker opens. In fact, the internally regulated alternator provides scant assistance to the battery for the purpose of getting the field breaker opened due to its relatively rapid response to the near-dead short across the field supply.

- (3) In the case where the b-lead contactor is used to unhook an internally regulated alternator, coil voltage to the 12v contactor falls to something under two volts. The contactor may stay closed at this rather low voltage. However, when the breaker does finally open and coil voltage goes to zero, the contactor will open much faster (1-3 milliseconds) than when de-energized from 14 volts with a spike catcher diode across it.
- (4) In all the cases cited, as long as the battery is well maintained, bus voltage never drops to values that would cause any device designed with the spirit of DO-160 in mind to do anything more than blink.

In the next revision to this document we'll explore the dynamics of an OV condition and the selection of trip voltage set points and time delay components necessary to maximize OV protection performance while minimizing nuisance trips.

Revision B

--> AeroElectric-List message posted by: "Gary Casey" <glcasey@adelphia.net>

All this talk about OV protection reminds me of a question I had way back that's never been answered. It goes something like this: If we assume the battery can be modeled by a voltage source in series with its internal resistance the behavior should be quite simple. We're sitting there with the battery fully charged and say I want to instantly draw 60 amps out of the battery. The voltage should drop according to the internal resistance - let's say it drops 1 volt. Let's instead that I suddenly push 60 amps of current into the battery. How high does the voltage go? If the model is correct it will rise 1 volt.

Great question!

One might easily assume that the battery model is the same whether receiving or supplying energy . .

As I understand batteries it will then start to generate gas and the bubbles will increase the internal resistance, allowing the voltage to start rising, eventually producing destructive events. Right or wrong?

I was going to look at ov relay design dynamics next but battery behavior in the OV event is also a part of this discussion. Let's go to the workbench and herd some electrons:

Let's take the same battery used in the last experiment and subject it to various degrees of overcharging stress:

Here's a 5A overcharge:

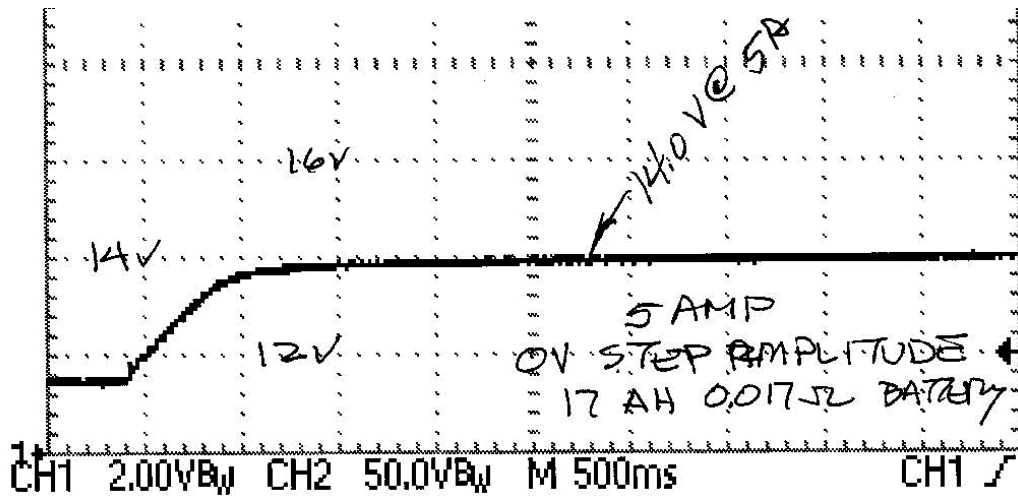

Here's a 10A overcharge:

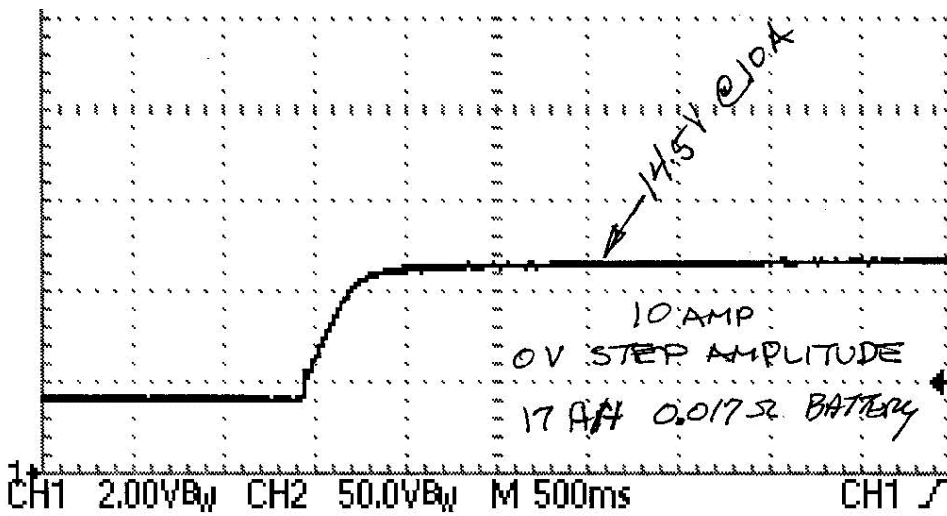

Here's a 20A overcharge:

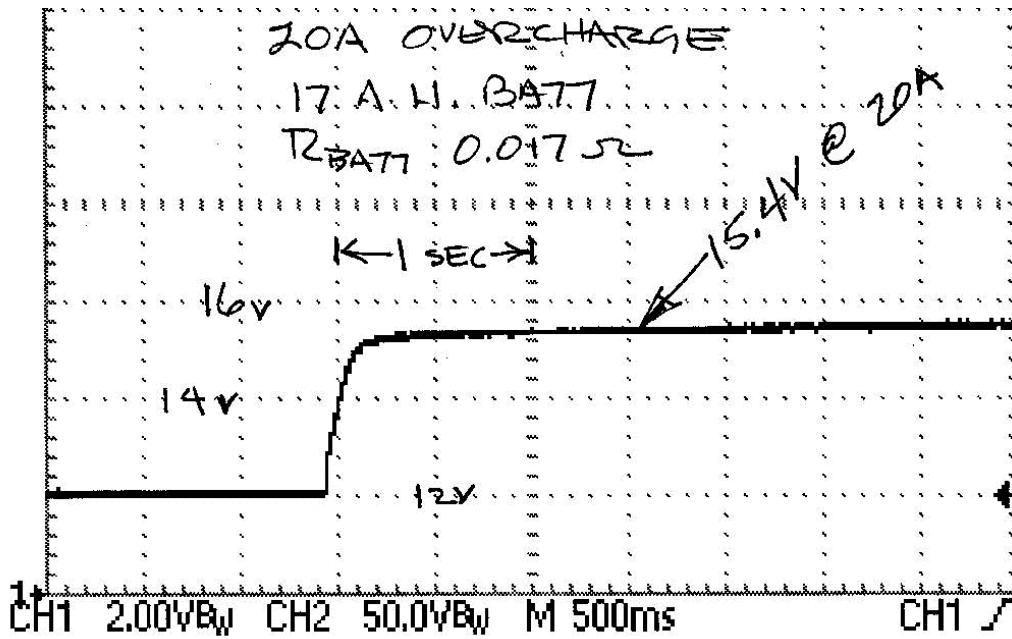

Finally, there's a 30A overcharge – note SLOWER time base

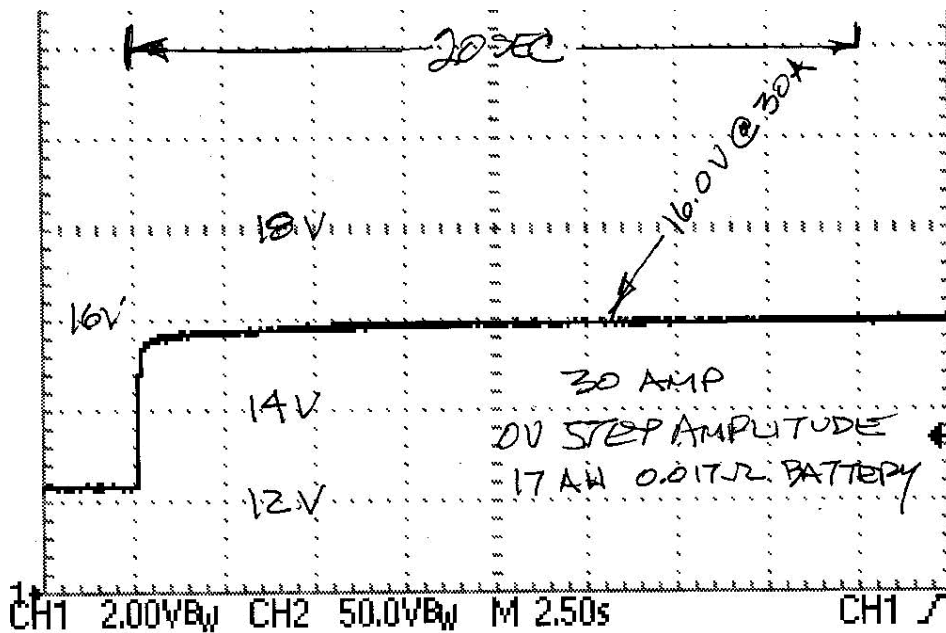

Here's how I would interpret the data just gathered:

- Note that the higher the overcharge current, the faster the voltage rises from the “pre-fault” condition.
- Note further that in about 2 second after onset of the “fault” the voltage settles out at some point higher than “pre-fault” but its rate of rise is not zero.
- Higher fault currents produce faster rates of rise before and after the plot’s “knee”.
- Higher fault currents produce successively higher endpoints of the initial rise.

Lets plot the “knee” endpoint data for the four test currents:

- The slope of this line is directly related to the “load impedance” of the battery as an acceptor of energy.
- Recall that in earlier experiments, this battery demonstrated a “source impedance” of about 0.017 ohms or 17 mΩ.
- Given the strong inflection in the curve below 5A, let’s take the interval between 10A and 30A where we see a ΔE of 1.5 volts over the ΔI range of 20A. This translates to an apparent “load impedance” in the charging mode of about 75 mΩ. Approximately 5 times higher than the battery’s performance as a source of energy.

Consider another battery characteristic of interest: Rate of voltage rise below the “knee”. Here’s another plot taken off the workbench.

- When we speed the ‘scope up during a 30A overcharge stress we see that initial rate of rise is on the order of 23 volts per second.
- From this test, it’s a reasonable deduction that a 60A overcharge stress will produce something on

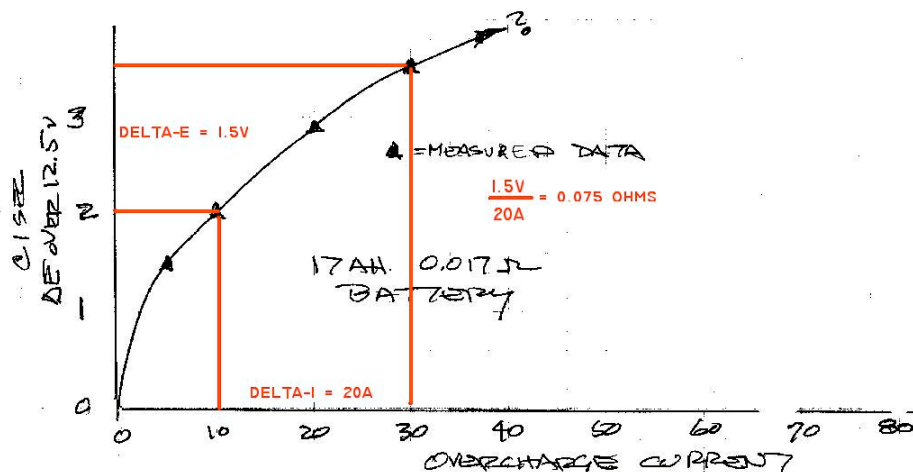

the order of a 46 volt per second rate of rise.

So taking the 0.075 ohm load impedance, we can extrapolate that a 60A overcharge stress will:

- Produce an after-knee voltage of about 18 volts. Perhaps less because I note that the plot of overcharge stresses versus voltage steps has a negative inflection . . . apparent source impedance may be going down somewhat . . . but this is in the ballpark.
- It's also a reasonable deduction voltage will get up there in $18-14.5(\Delta E)/46$ (volts/second) or about 75 milliseconds.

Okay, what alternator produces a balls-to-the-wall effort of 60A? Probably one rated at 50A or perhaps even 45A.

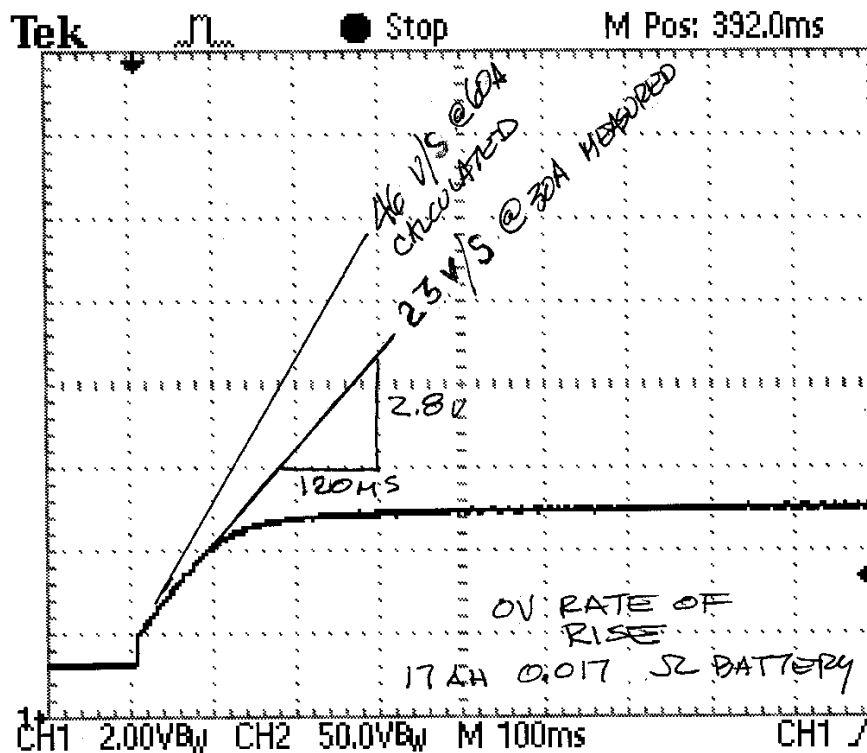

I think this experiment illustrates the battery's value as the grand mitigator of bad scenes. Suppose the battery were longer in the tooth? How would rate of rise and after-knee voltages differ? They would be faster and higher. If the battery were newer than the test battery, the rate of rise would be slower and the voltage lower for the same OV event. If the battery were totally out of the circuit, then the battery's ability to soak up excess alternator output and limit both after-knee voltage and rate of rise would be missing. Now we would have to consider the ability of ship's loads to use the excess energy. Guess what, it's not very good. Rate of rise would be much faster and the "knee" (if there is one) is much higher too. If the OV protection system were in place, the system voltage would get a bit higher before it's caught because rate of rise is much faster . . .

When the alternator stand gets here, we'll see about gathering data on a simulated OV event with a 40A alternator and see how well the deduced numbers above agree with real numbers taken from the larger experiment.

Suppose we had an itty-bitty, 25A alternator that OV faults at 30A. How long would it take for the OV protection system to take the alternator off line?

- If it were a brand new or larger battery, it might take 30 seconds to perhaps forever depending on how much of the excess output was being used by the system.
- In all cases cited above, we're assuming zero system loads. Therefore, rates of rise go down and knee-end voltages go lower as more equipment soaks up excess alternator output.

Philosophy question to ponder: What are the ov hazards for the small SD-8 alternator or the “gee-I-wish-I-were-a-real-alternator” on a Rotax? The only time one of these alternators will be able to produce a hazardous OV condition is if the battery is allowed to get REALLY soggy or becomes disconnected. Yes Virginia, there are folks flying these small alternators with small engines having very low or perhaps no cranking current requirements. Batteries on those aircraft are at-risk for being in service long after their prime. As one who offers system architecture suggestions, I cannot leave OV protection out of these small systems. If I personally owned and flew a small system aircraft, I probably wouldn't have an OV protection system because maintenance of battery performance is very high on my personal list of system requirements. An LV/OV warning light would probably suffice nicely.

- The battery is your best and most effective friend in the power generation, filtering, storage and fault management. This will become more apparent as this discussion moves forward.

Revision –C-

Let's consider circuit breaker ratings and limits. I've acquired some samples of circuit breakers widely applied at RAC. These are Eaton/Mechanical Products devices built to MS26574 and offered commercially as their model 4200 series breakers. A detailed data sheet has been posted at:

http://www.aeroelectric.com/Mfgr_Data/Breakers/Eaton_4200.pdf

Referring to the specification above we find this chart:

PERFORMANCE DATA

| | |
|------------------------------|---|
| Interrupting Capacity | 1 to 5A: unlimited at 28V DC; 7 1/2 to 25A: 2,000A at 28V DC 1 to 1 1/2A: unlimited at 120V 400 Hz., AC 2 to 5A: 800A at 120V, 400 Hz., AC 7 1/2 to 25A: 500 amps at 120V, 400 Hz., AC |
| Endurance* | At 120V, 400 Hz., AC or at 28V, DC: inductive load — 2,500 cycles; resistive load — 5,000 cycles; mechanical cycling, no load — 5,000 cycles |
| Overload Cycling | Minimum of 100 cycles at 200% rated current |
| Dielectric Strength | At sea level, 25°C 1,500V, AC. At 80,000 ft. 71°C 500V, AC |
| Insulation Resistance | Not less than 100 megohms at 500V, DC |
| Voltage Drop | Varies with rating (see "Ordering Information") |
| Vibration* | Meets specification MIL-STD-202, Method 204, Condition A 10-57 Hz. 06 in. Displacement Double Amplitude, and 57-500 Hz. at 10G's (Random vibration level also available) |
| Shock* | Exceeds 50G's, 11 Millisec (half-sine pulse) MIL-STD-202, Method 213A Test A |
| Acceleration | Exceeds 10G's |
| Weight | 22 grams (0.048 lbs.) |

* Variations of these circuit breakers are capable of exceeding the standard Mil specification for endurance, vibration, and shock. Consult the business unit for more information.

I'll call the reader's attention to the values for Interrupting Capacity where we see that breakers in the 1 to 5A range have NO LIMIT to the fault current that can be allowed to flow in a 28v system. This means that no matter how high the initial fault current, the fire will go out as the contacts open and the breaker will function as advertised.

Take a look also at the Trip Curve for current versus time. Like most breakers of this genre' the ratings chart is plotted out to 1000% of the breaker rated trip point. However, this chart does go out to 10,000% (100x) . . . nothing is plotted into this area. Many manufacturers plot to 1000% and quit.

This method of stating performance is often mistaken as a LIMIT to the maximum current the breaker can be expected to handle. I've sketched in extensions to the plotted curves which include the range of operation for experiments elsewhere in this document. I'll suggest that in light of absolute interruption limits (or lack thereof) stated in words elsewhere in the specification that extrapolation of the breaker's performance by test or sketching extensions of the curves beyond 1000% is a valid exercise.

TRIP CURVE

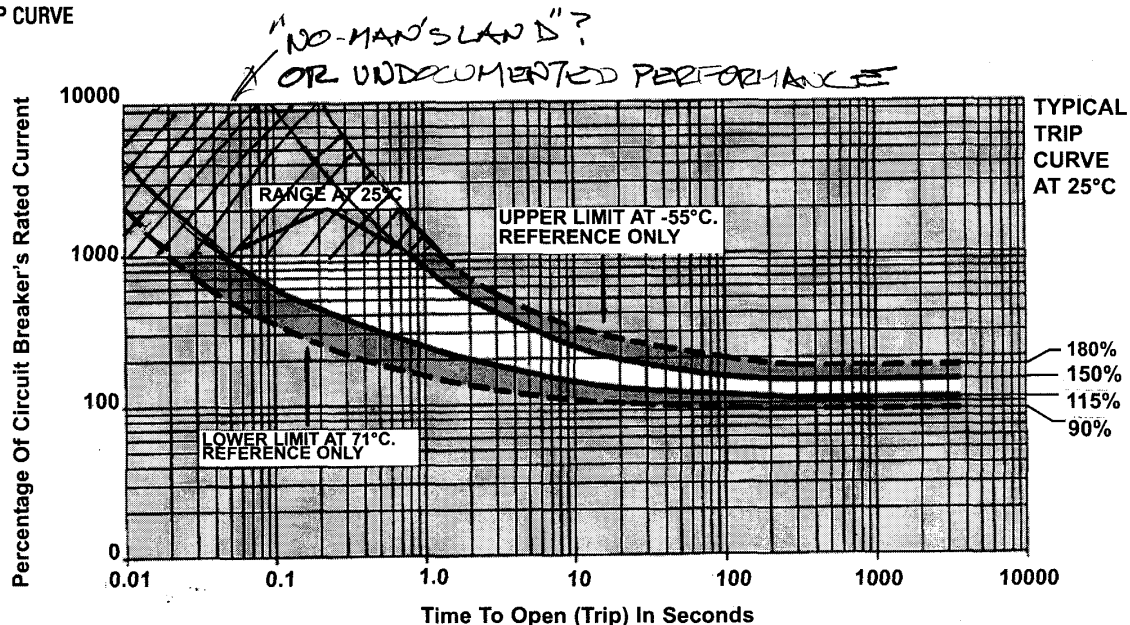

Revision -D- Pending

Unless a question prompts a different topic for revision D, the next installment will explore the dynamics of OV sensing and find out where the 16.25 voltage setting comes. We'll explore how we choose transient response in the OV sensing system.

Keep in mind that we're still not talking about the philosophy of any particular system of protection . . . this stuff is generic to system performance irrespective of the hardware choices.